

- INPUT IS 120 VAC / 60 HZ
- FULLY DIMMABLE, WITH LOW-VOLTAGE MAGNETIC DIMMER
- 1/8" STEEL, POWDER COATED NEMA 3R CASE
- THE TRANSFORMER HAS 5 EACH 4 AMP BREAKERS / CLASS 2 LISTED OUTPUTS
- MEETS OR EXCEEDS ALL UL, CUL, ANSI/UL, CSA REQUIREMENTS
- LISTED TO THE NEWEST UL STANDARDS 2108 AND 1838
- MANDATORY SECONDARY PROTECTION AS STATED IN THE NATIONAL ELECTRIC CODE ARTICLE 411,(1993, 1996, 1999, 2002, 2005, AND 2008)
- TRANSFORMER IS ETL LISTED
- WEIGHT: 19 LBS./ 8.7 Kg

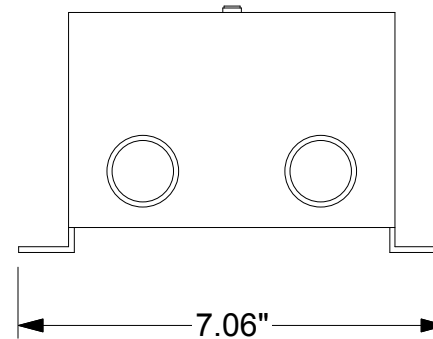
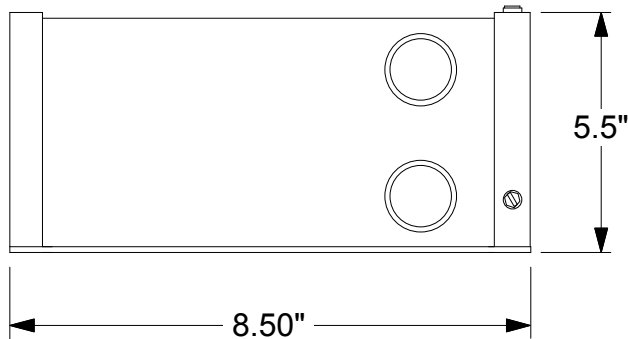

TOKISTAR LIGHTING INC.

1015 E. DISCOVERY LANE
ANAHEIM, CA 92801
TEL: 714 772 7005 FAX: 714 772 7014
email: info@tokistar.com Website: tokistar.com

Part No. C2-480-24V

480 VA Transformer Input: 120 VAC / Output: 24 VAC